

Drift.

aspect 

Experience infinite configuration possibilities with Drift modular seating.

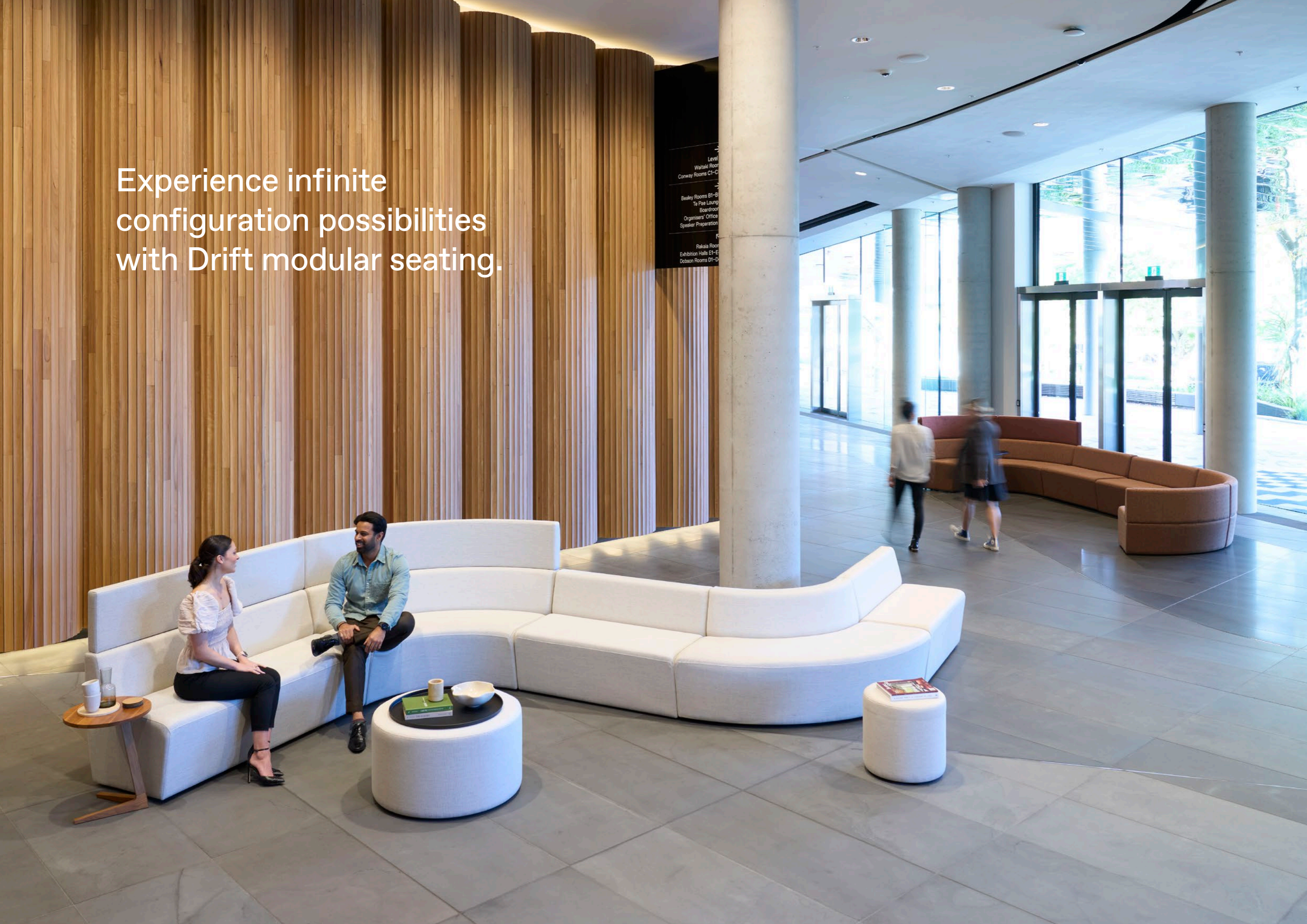

In the ever-evolving landscape of workplace design, the need for more connection and collaboration remains constant. As the boundaries between public and private workspaces blur, the demand for versatile solutions in reception, break-out and meeting areas has become increasingly apparent. Inspired by changing movements and natural forms, Drift is a dynamic and flexible solution that fosters connection and facilitates collaboration within the workplace.

The Drift collection balances soft seating comfort and style with workplace functionality and longevity.

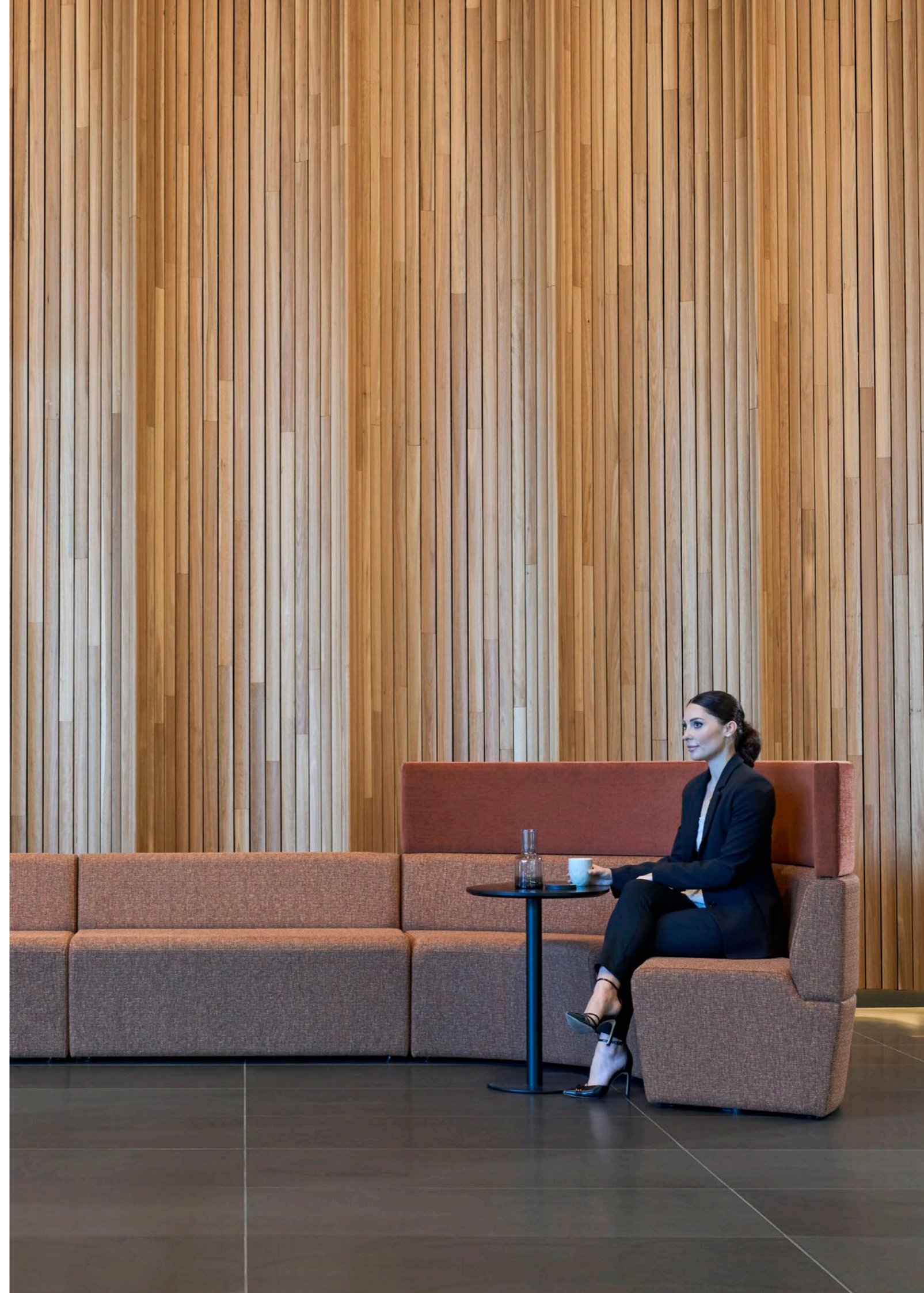



The Drift range allows you to establish agile zones without the need for walls, offering seating configurations for open areas as well as semi-private and private spaces.



Designed and made in New Zealand.

Drift is designed and manufactured in New Zealand by Aspect's in-house team. Our commitment to using sustainably sourced materials ensures the highest quality, consistency and timely delivery of our products.

As furniture designers, our user-centric approach places people at the heart of every decision we make. Drift has been designed to bring people together and we know it will foster productivity, connection and collaboration in its new home.



Drift's organic shapes are a nod to its surroundings, capturing the gentle, ever-changing movements observed in nature. Its seamless blend of earth-inspired aesthetics, materiality and comfort encourages a collaborative flow within the workplace.

Drift modules connect
to shape your space.



Modular design.

Drift modular seating is designed to change with its environment. Modules are easily reconfigured and built upon as spatial requirements and workplace needs evolve.

A collection of base seat units can exist alone or come together to create fluid, organic shapes or traditional sofa formats. Screens can be added for height, privacy and acoustic shielding.

Drift's modular components are made to adapt, change and move with ease.





Drift collection.

Drift full.

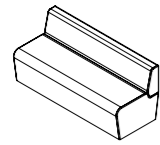

Full straight.



Full 60° concave.



Full 90° concave.

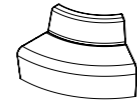

Full 60° convex.

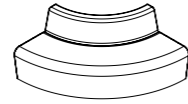

Full 90° convex.

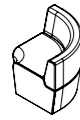

Full corner rounded.

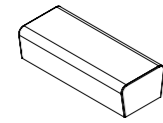

Full ottoman straight.



Full ottoman 60°.



Full ottoman 90°.

Drift lite.

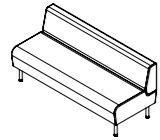

Lite straight.



Lite 60° concave.



Lite 90° concave.

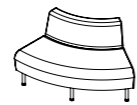

Lite 60° convex.

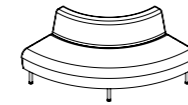

Lite 90° convex.



Lite corner rounded.

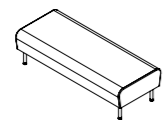

Lite ottoman straight.



Lite ottoman 60°.



Lite ottoman 90°.

Drift media pod.

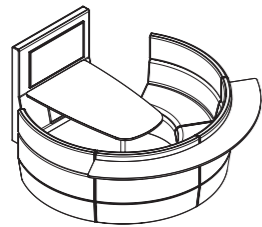

Drift accessories.

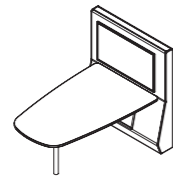

Media unit.

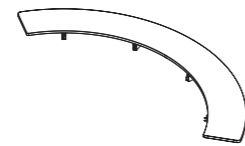

Bar leaner.

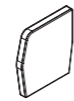

Armrest full.



Armrest lite.

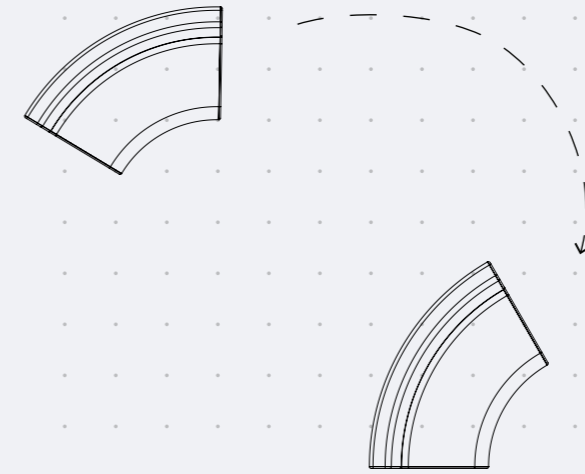

Connect

Create

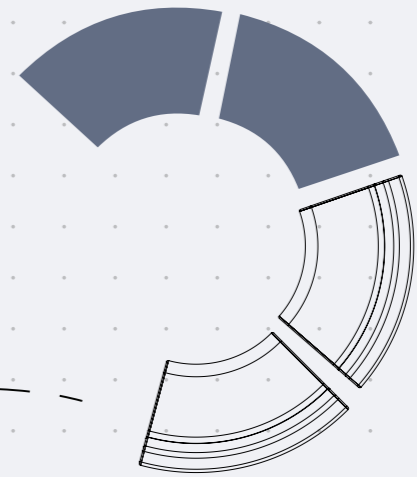

Experience

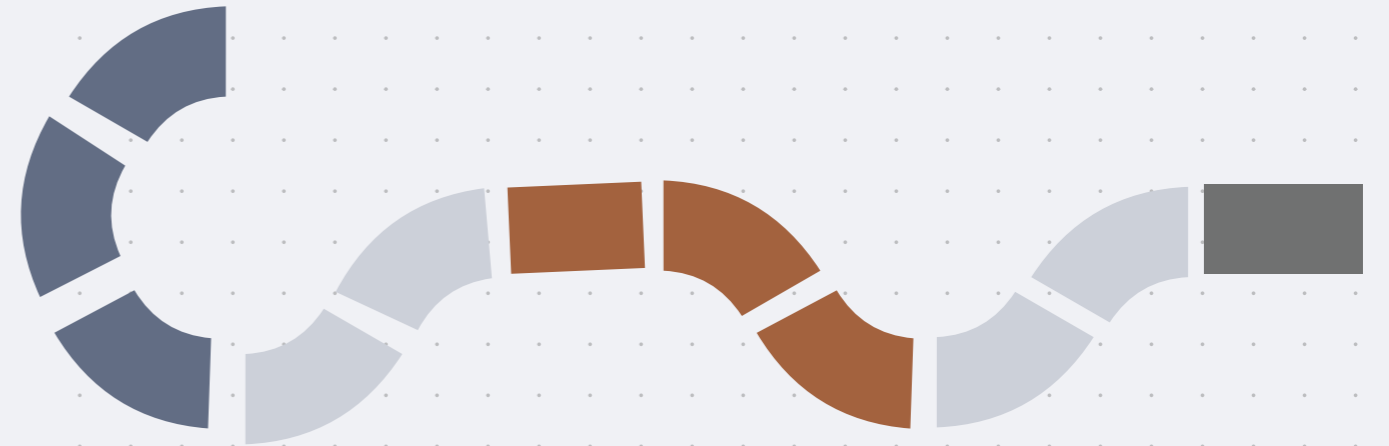

Drift full modules.

Drift full module seat height & foot detail.



Full straight module.

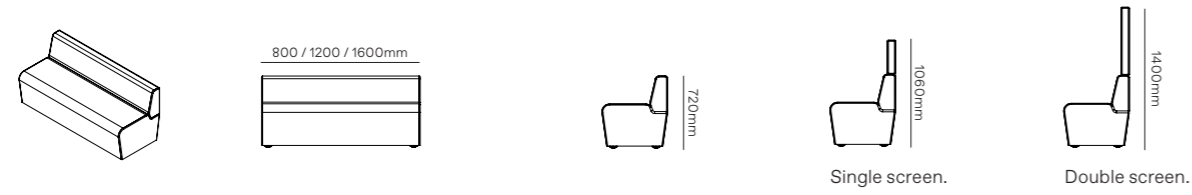

Full concave 60° degree module.

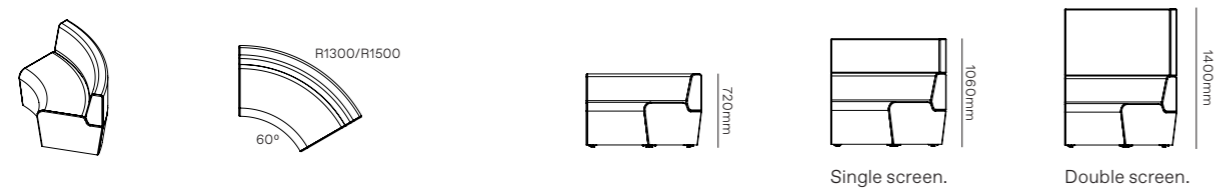

Full concave 90° degree module.

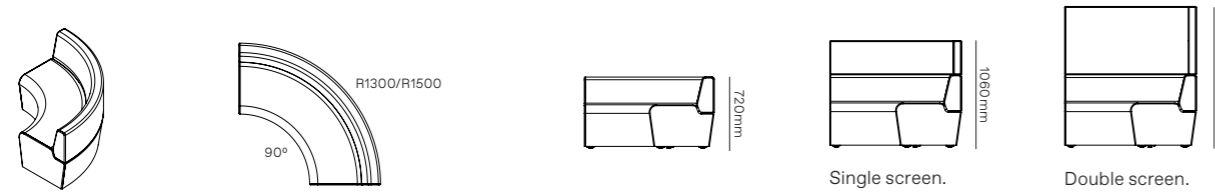

Full convex 60° degree module.

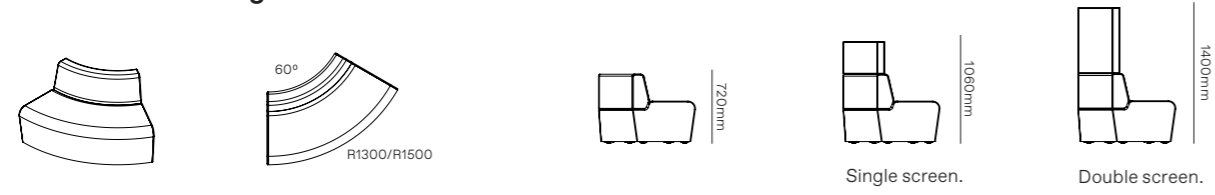

Drift full modules.

Full convex 90° degree module.

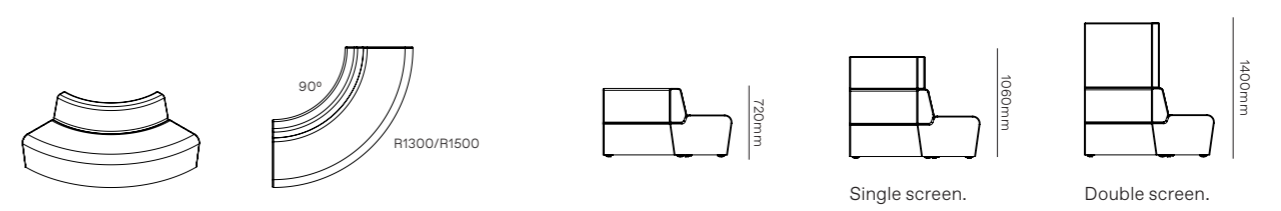

Full corner rounded.

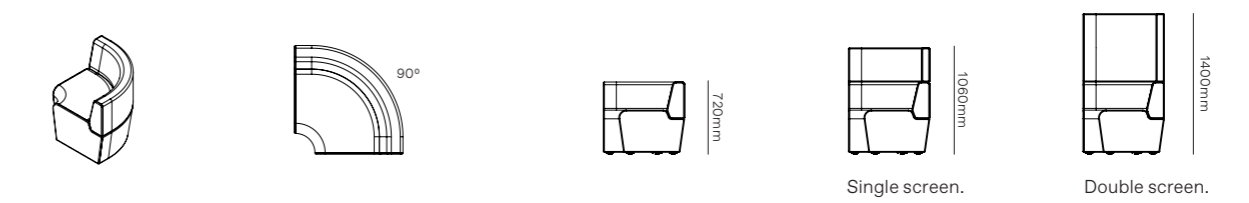

Full ottoman straight.

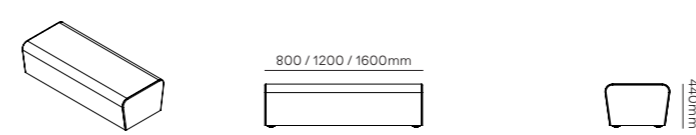

Full ottoman 60° degree.

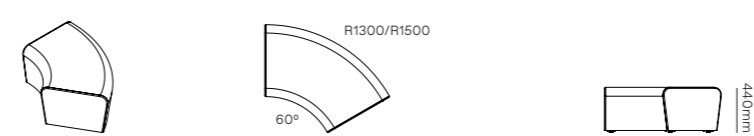

Full ottoman 90° degree.

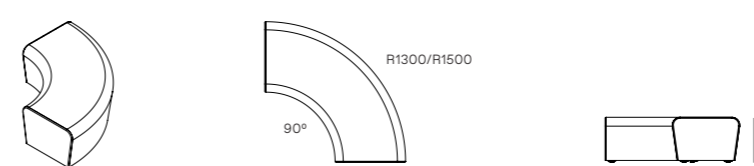

Drift lite modules.

Drift lite module seat height & foot detail.



Lite straight module.

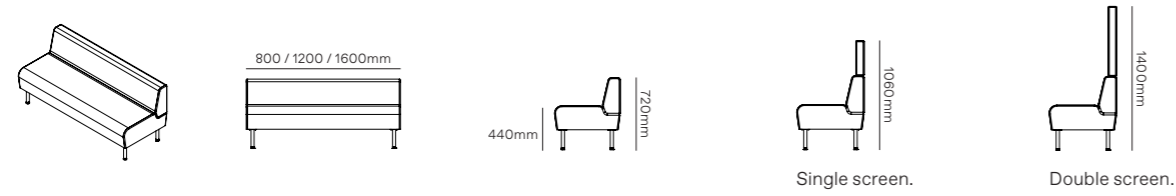

Lite concave 60° degree module.

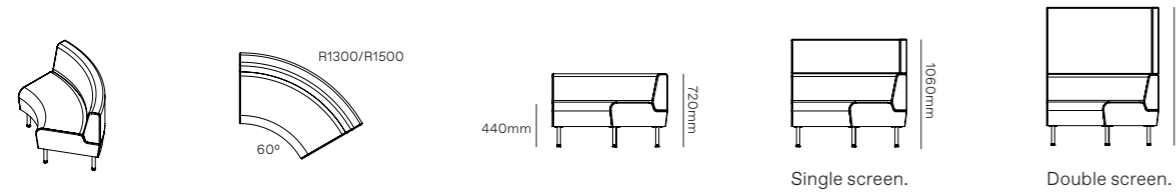

Lite concave 90° degree module.

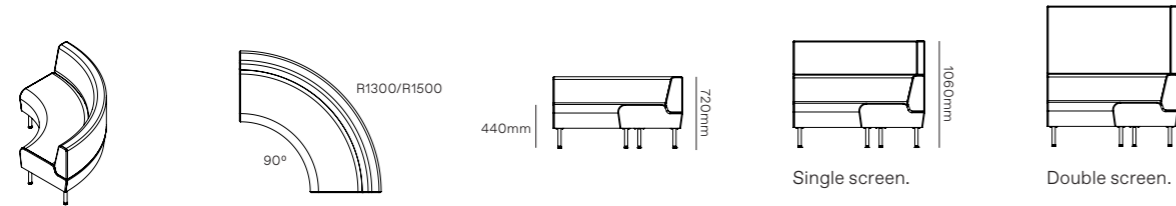

Lite convex 60° degree module.

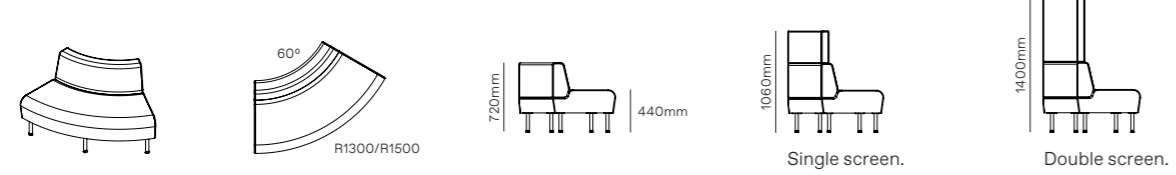

Drift lite modules.

Lite convex 90° degree module.

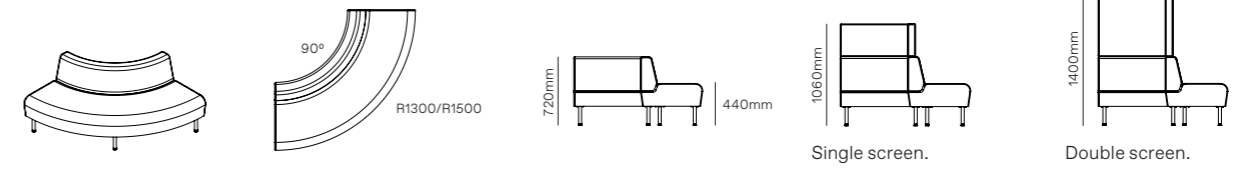

Lite full corner rounded module.

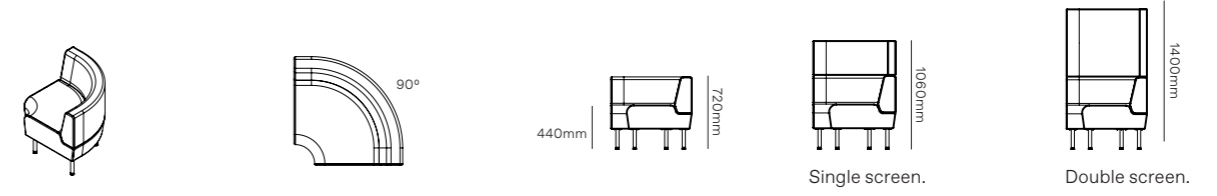

Lite ottoman straight.

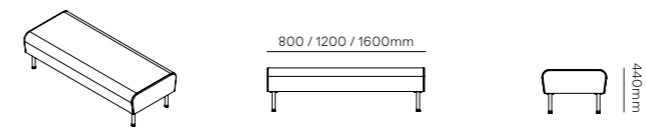

Lite 60° degree ottoman.

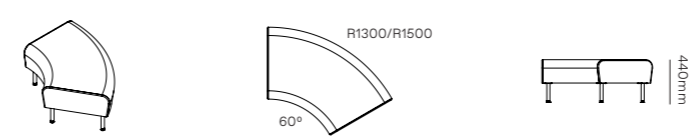

Lite 90° degree ottoman.

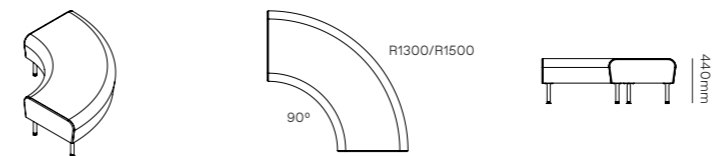

Collab settings.

Drift's collaborative settings are a space for conversation and creativity to flourish.

Drift seamlessly integrates technology, including interactive visual displays, making it an ideal place to host meetings and presentations.

Adding to the collection,
Drift Collab settings
provide a space to meet
and work together.



Drift Collab settings.

Collab setting with media unit.

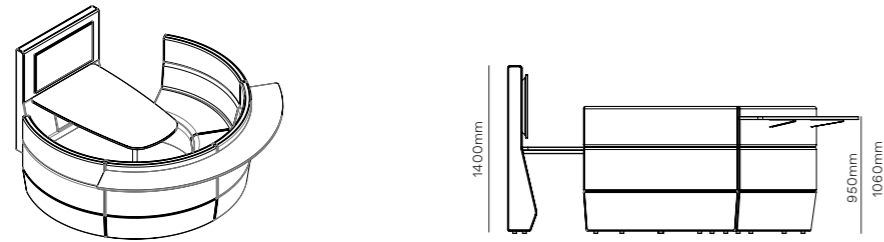

Media unit.

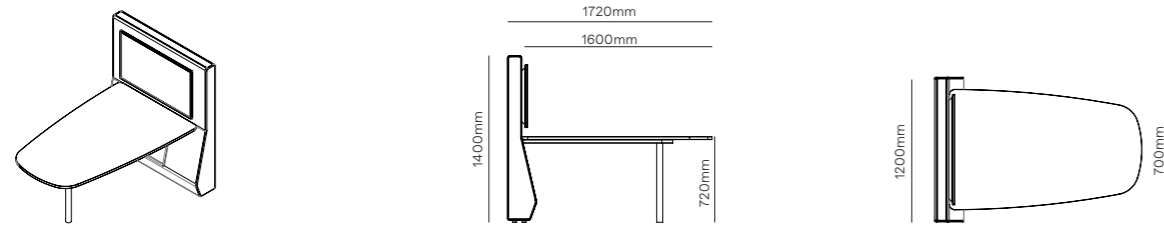

Drift accessories.

Bar leaner.

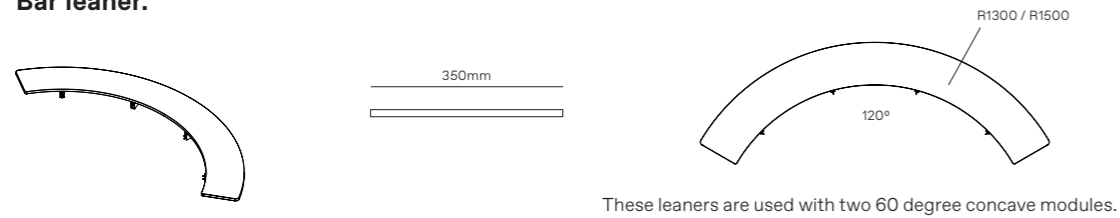

These leaners are used with two 60 degree concave modules.

Armrest full.

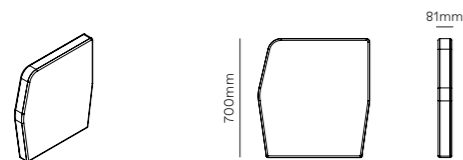

Armrest lite.



Example configurations.

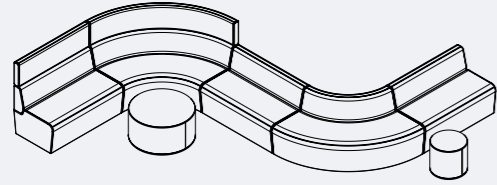

Configuration 01.

- 1x 1200W full straight, single screen
- 1x 1300R full 90° concave, single screen
- 2x 1200W full straight
- 1x 1300R full 90° convex

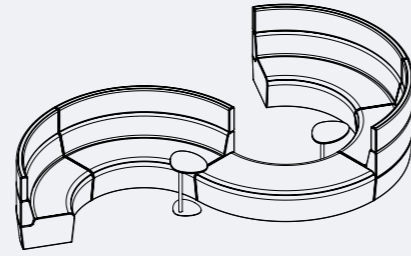

Configuration 02.

- 2x 1500R full 90° concave, single screen
- 1x 1500R full 90° ottoman
- 2x 1500R full 60° concave, single screen

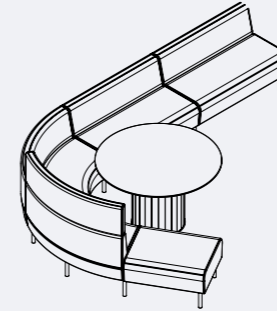

Configuration 03.

- 1x lite 800W straight ottoman
- 1x lite 1300R 60° concave, single screen
- 1x lite 1300R 60° concave
- 2x lite 1200W straight

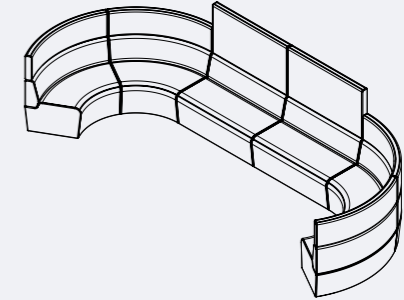

Configuration 04.

- 2x full 1200W straight, double screen
- 4x full 1300R 60° concave, single screen

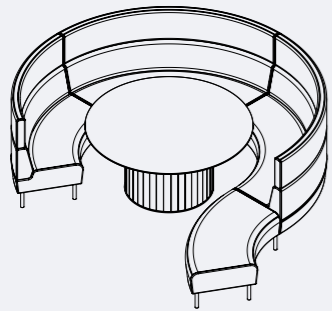

Configuration 05.

- 2x lite 1500R 90° concave, single screen
- 1x lite 1500R 60° concave, single screen
- 1x lite 1500R 60° ottoman

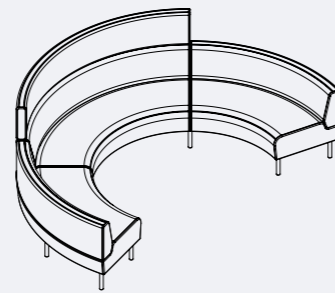

Configuration 06.

- 1x lite 1500R 90° concave, single screen
- 2x lite 1500R 60° concave

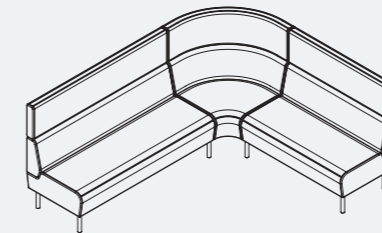

Configuration 07.

- 1x lite 1600W straight, single screen
- 1x lite corner, single screen
- 1x lite 1200W straight, single screen

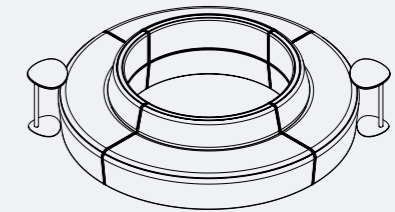

Configuration 08.

- 4x full 90° 1500R convex



Product details.

Finishes	Custom upholstery available Upholstered in New Zealand
Variations	Drift full, Drift lite, Drift Collab setting Standard Ash Timber or powdercoated Mannex Black steel legs (Drift lite) Custom finishes available
Warranty	10-Year warranty for normal commercial use Fabric as per manufacturers warranty
Lead Time	4–8 weeks



We believe that high-performing spaces enable high-performing people.

We place a person's comfort and ease-of-use at the heart of every product and system we create. Aspect designers and workplace specialists help you create a complete office furniture solution that will inspire and support people in their work every day.

Back in 1982, from a small factory in Auckland, Aspect founder and CEO Richard Simmons made his very first furniture prototypes. Driven by a passion for craft and beautiful engineering, he steadily grew the business and is joined today by his three sons and an expert team of designers, engineers and workplace specialists across New Zealand and Australia. Today, Aspect makes collections at the leading edge of international product design, technology, and workplace best practice.

Our focus on crafted, fully resolved commercial furniture means Aspect collections are trusted by some of the largest public and private organisations around Australasia. With over 40 years' experience designing and manufacturing collections for the modern workplace, our office furniture has a reputation for being robust, ergonomic, and comfortable throughout the working day.

We make over 70 per cent of our product range in New Zealand and Australia for true control over design, quality, customisation, and lead times. You receive products quickly and reliably from a quality-assured environment. In addition to speed and

flexibility, local manufacturing also creates a smaller environmental footprint.

Our team of product designers and workplace specialists help you define and select a furniture solution to meet your workplace aspirations and project budget using durable and environmentally sound products.

Direct access to our furniture designers means greater flexibility and control over your solution, as we work from our collections, adapt existing products, or design new components.

Aspect Furniture operates ethical and sustainable business practices. We have certification from Good Environmental Choice Australia (GECA) and Environmental Choice New Zealand (ECNZ), and our products are aligned to the Green Star rating tool. Independent certifiers regularly audit our premises under the ISO 9001 and ISO 14001 quality and environmental management systems. Similarly, the health and safety of our employees is vital to our success, so we are certified to the globally recognised AS/NZS 4801 and ISO 45001 occupational health and safety standards.



ISO 9001
ISO 14001
ISO 45001



Furniture, Fittings
and Flooring
Licence Number
3210076



An Aspect product. Designed by Aspect.

Made in New Zealand.





New Zealand

0800 323 220
info@aspectfurniture.com

Australia

1800 696 334
infoau@aspectfurniture.com

aspectfurniture.com

Showrooms

Auckland
Wellington
Christchurch
Sydney
Melbourne
Canberra